

MMBT5401 TRANSISTOR (PNP)

FEATURES

Complementary to MMBT5551

Ideal for medium power amplification and switching

SOT-23

1. BASE
2. EMITTER
3. COLLECTOR

MARKING: 2L

MAXIMUM RATINGS ($T_A=25^{\circ}\text{C}$ unless otherwise noted)

Symbol	Parameter	Value	Units
V_{CBO}	Collector-Base Voltage	-160	V
V_{CEO}	Collector-Emitter Voltage	-150	V
V_{EBO}	Emitter-Base Voltage	-5	V
I_C	Collector Current -Continuous	-0.6	A
P_C	Collector Power Dissipation	0.3	W
T_j	Junction Temperature	150	$^{\circ}\text{C}$
T_{stg}	Storage Temperature	-55-150	$^{\circ}\text{C}$

ELECTRICAL CHARACTERISTICS ($T_{amb}=25^{\circ}\text{C}$ unless otherwise specified)

Parameter	Symbol	Test conditions	MIN	MAX	UNIT
Collector-base breakdown voltage	$V_{(BR)CBO}$	$I_C = -100\mu\text{A}$, $I_E = 0$	-160		V
Collector-emitter breakdown voltage	$V_{(BR)CEO}$	$I_C = -1\text{mA}$, $I_B = 0$	-150		V
Emitter-base breakdown voltage	$V_{(BR)EBO}$	$I_E = -10\mu\text{A}$, $I_C = 0$	-5		V
Collector cut-off current	I_{CBO}	$V_{CB} = -120\text{V}$, $I_E = 0$		-0.1	μA
Emitter cut-off current	I_{EBO}	$V_{EB} = -4\text{V}$, $I_C = 0$		-0.1	μA
DC current gain	h_{FE1}	$V_{CE} = -5\text{V}$, $I_C = -1\text{mA}$	80		
	h_{FE2}	$V_{CE} = -5\text{V}$, $I_C = -10\text{mA}$	100	300	
	h_{FE3}	$V_{CE} = -5\text{V}$, $I_C = -50\text{mA}$	50		
Collector-emitter saturation voltage	$V_{CE(sat)}$	$I_C = -50\text{mA}$, $I_B = -5\text{mA}$		-0.5	V
Base-emitter saturation voltage	$V_{BE(sat)}$	$I_C = -50\text{mA}$, $I_B = -5\text{mA}$		-1	V
Transition frequency	f_T	$V_{CE} = -5\text{V}$, $I_C = -10\text{mA}$	100		MHz

Typical Characteristics

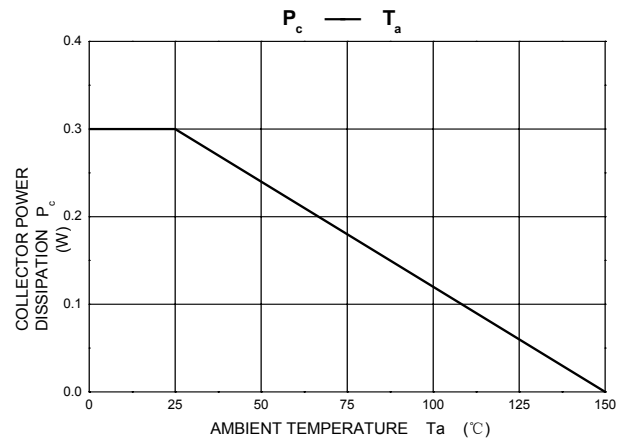
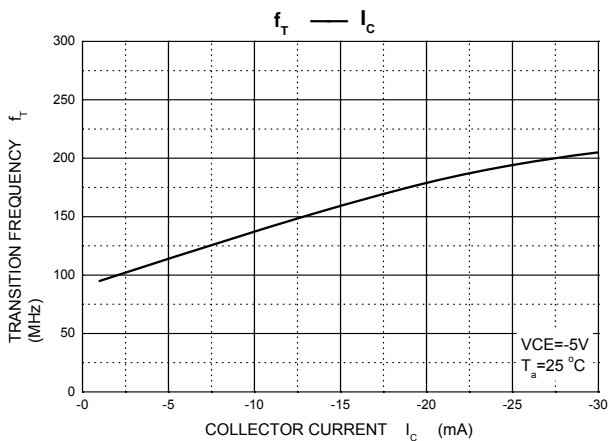
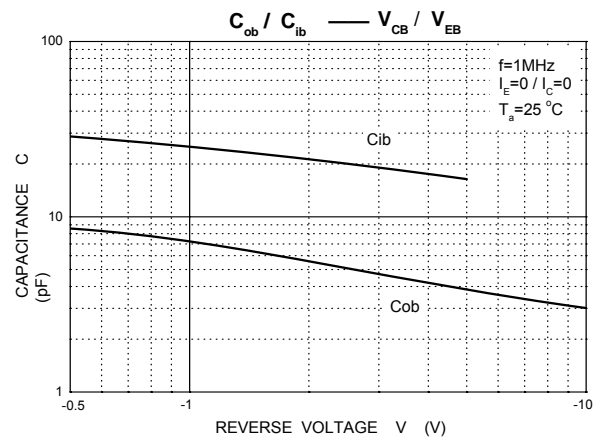
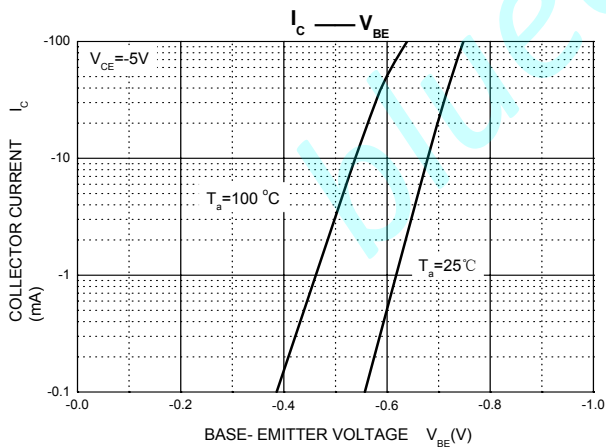
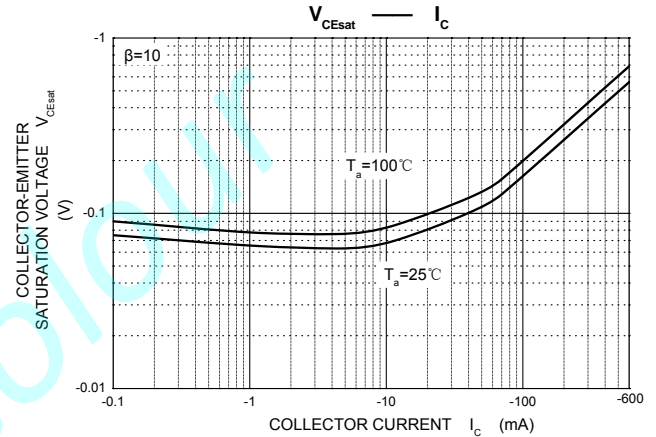
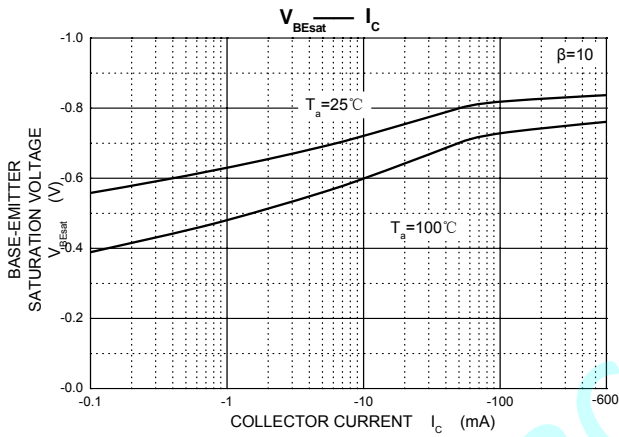
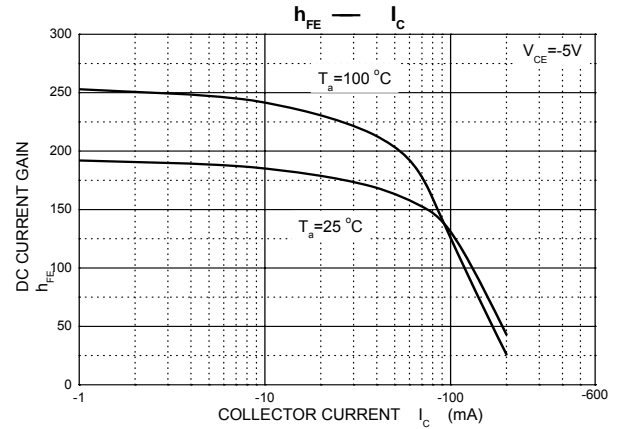
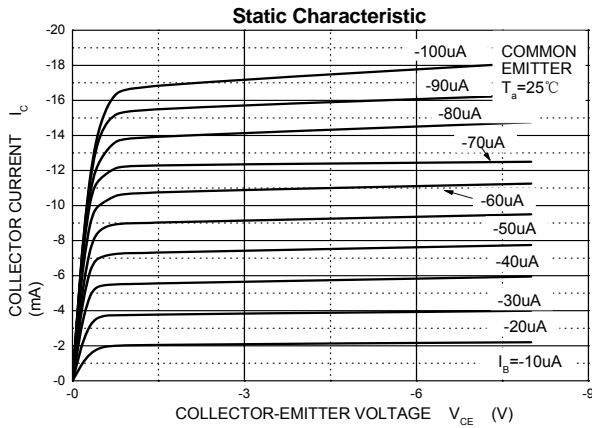

PACKAGE OUTLINE

Plastic surface mounted package; 3 leads

SOT-23

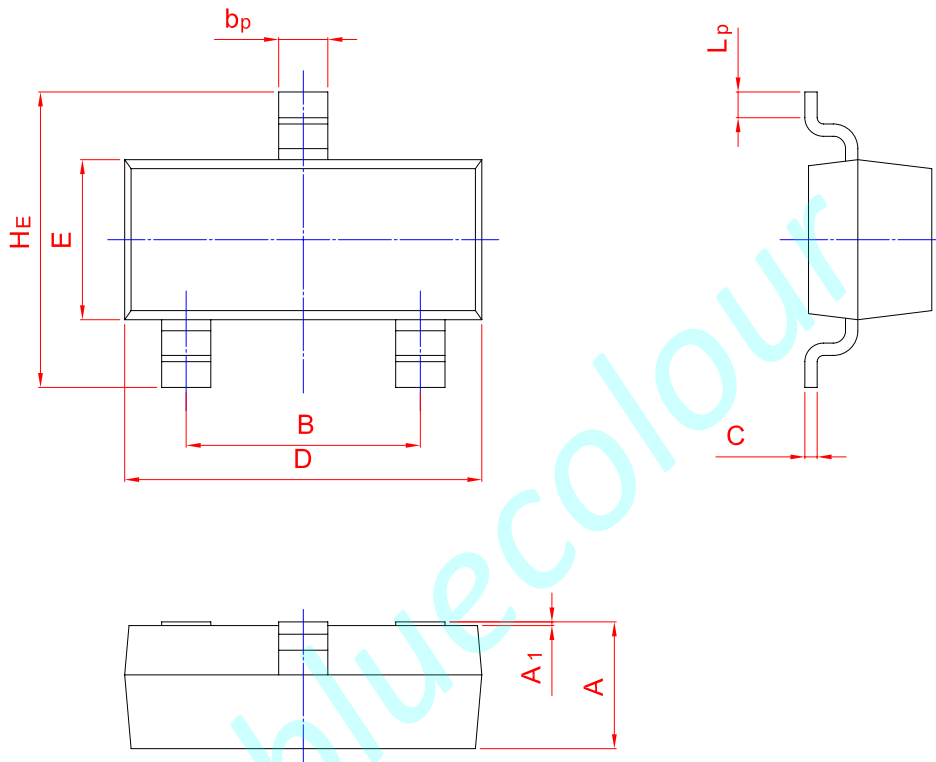
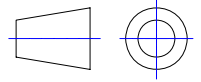

UNIT	A	B	bp	C	D	E	HE	A1	Lp
mm	1.40	2.04	0.50	0.19	3.10	1.65	3.00	0.100	0.50
	0.95	1.78	0.35	0.08	2.70	1.20	2.20	0.013	0.20